

ROOM

WWW.ROOMONLINE.COM

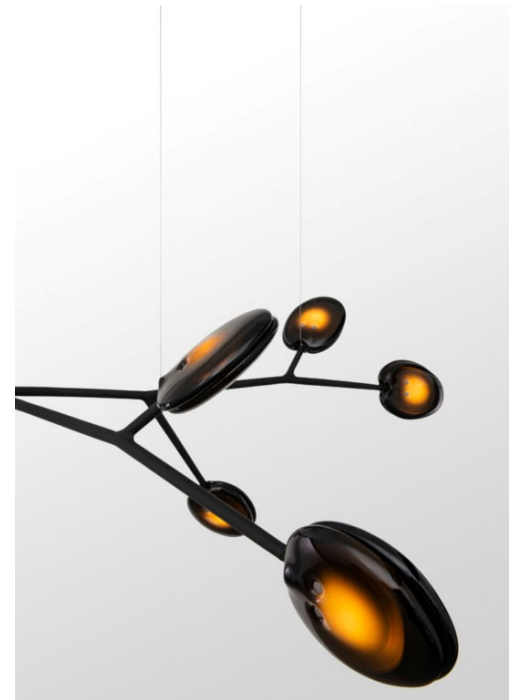

BOCCI 16 ARMATURE

FIXTURES AVAILABLE IN A NUMBER OF PENDANTS RANGING FROM 3 TO 26; FOUR COLORS AVAILABLE

POURED GLASS AND STEEL ARMATURE COMPONENTS, WITH SEMI-MATTE, POWDER-COAT BLACK FINISH

ITEM NO. LI251

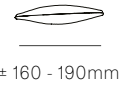
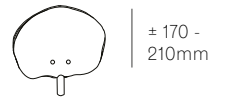
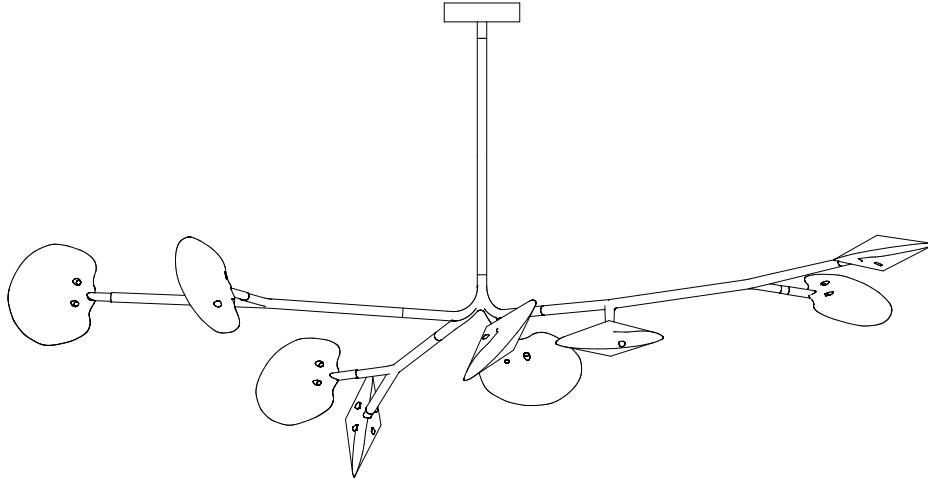

Image shown above 16.9a.1, 500mm extender

Mounting	Ceiling mounted
Glass Colours	Grey 1, grey 2, white 1, white 2
Lamp	1W LED, 2700K, 100lm (2500K and 3000K options available)
Extenders	Available in 150mm, 250mm, 500mm, 1200mm, 750mm (attached with 2 pendants). Up to 2500mm drop
Finish	Black powder coated
Materials	Poured glass, black powder coated stainless steel armature, electrical components, matte black canopy
Power Supply	Integral Bocci recommends remote mounting power supplies for ease of long-term maintenance.
Environment	Indoor, dry location. IP20
Note	Optional levelling pendant anchor kit included. Every single Bocci product is handmade. They are blown, poured, carved, polished, packed and dispatched directly by us. As such, no two products are identical; they are individual, irregular expressions of our research.
Patent #	CAN 16234 US D754,911 EU 002687774 - 0001 to 0012

Certifications



Weight (kg)

16.5a.1	16.7
16.8a.1	26.6
16.8a.2	28.2
16.9a.1	25.8
16.9a.2	29.5
16.11a.1	38.1
16.11a.2	36.2
16.13a.1	42.9
16.17a.1	55.7
16.20a.1	67.1
16.23a.1	78.7
16.33a.1	112.9

Each product is unique, there may be a variance in the weight up to 10%.

16.5A.1

All dimensions are in millimeters (mm) unless otherwise specified.

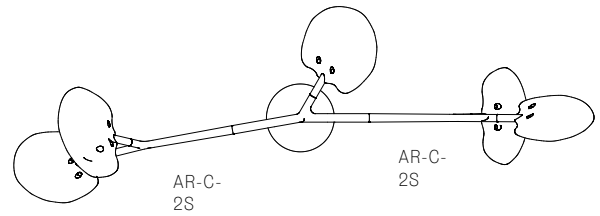
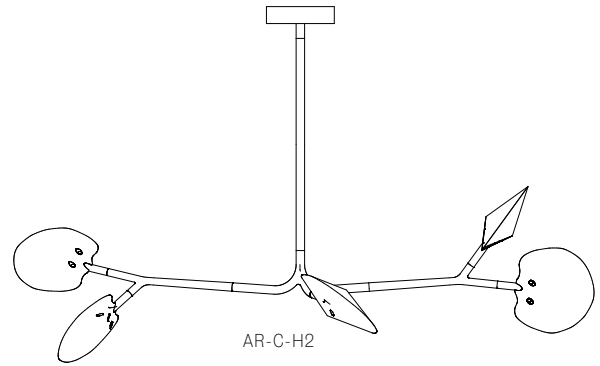
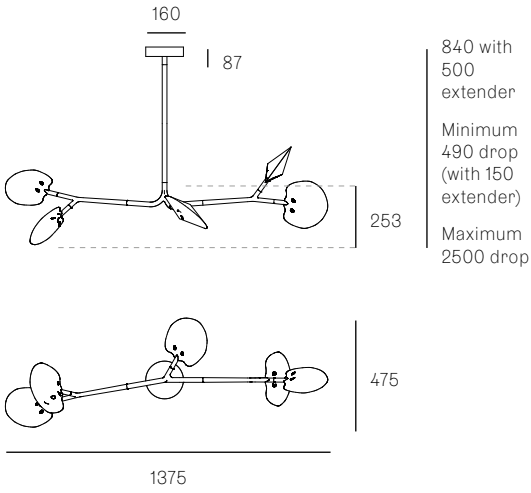

16.8A.1

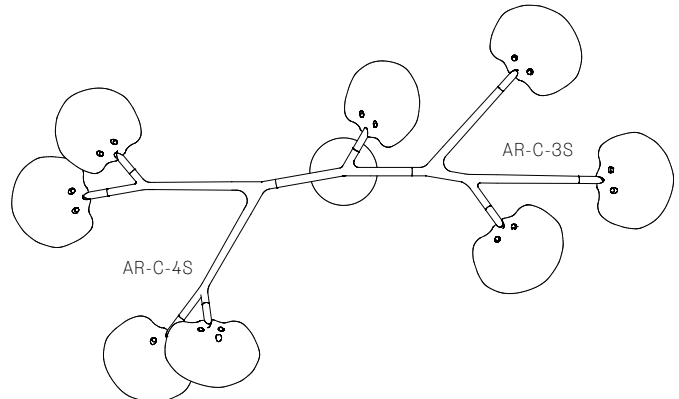
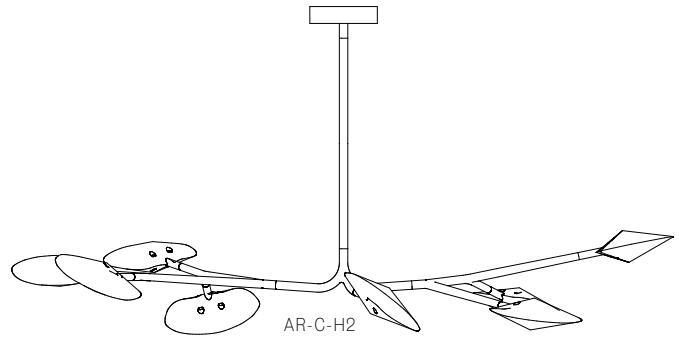
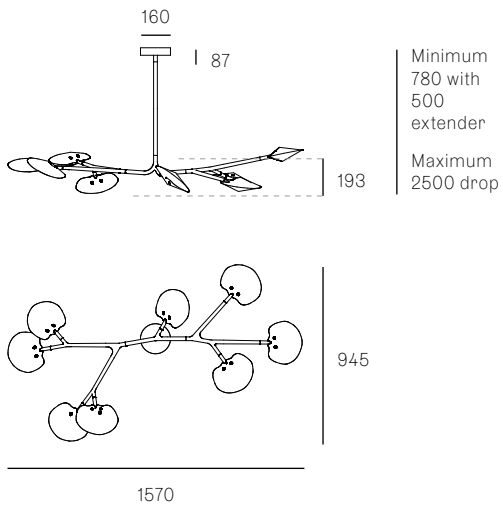

16.8A.2

All dimensions are in millimeters (mm) unless otherwise specified.

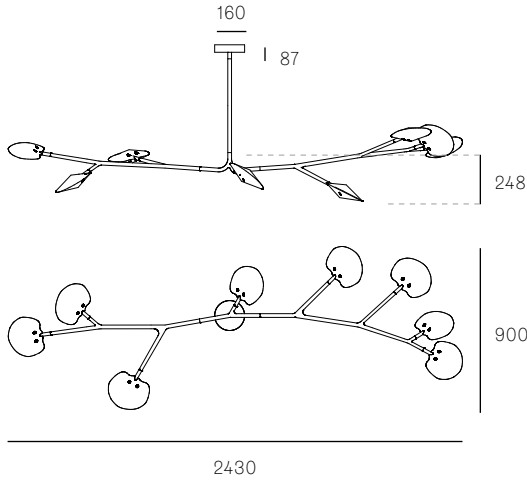

Minimum
835 with
500
extender
Maximum
2500 drop

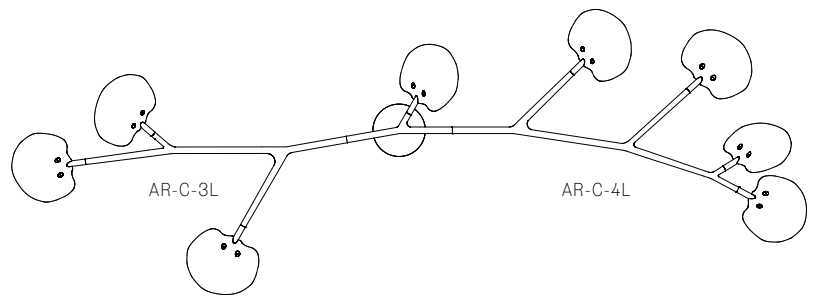
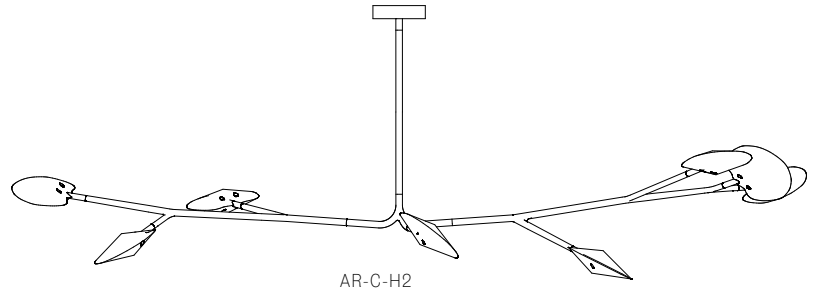

16.9A.1

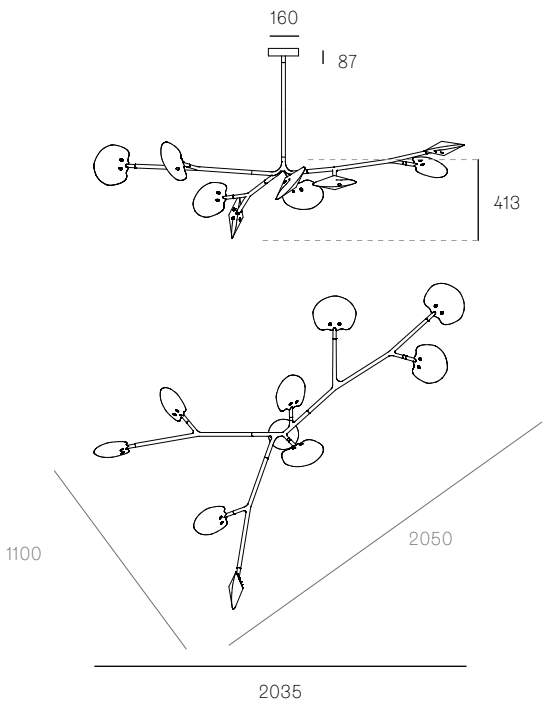

Minimum
1000
with 500
extender
Maximum
2500 drop

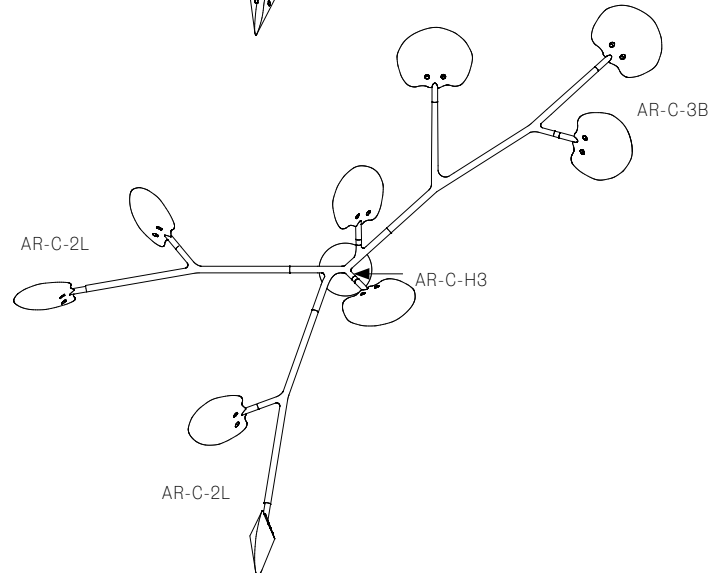
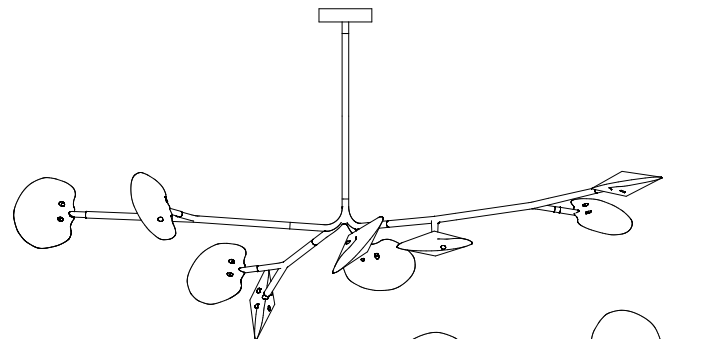

16.9A.2

All dimensions are in millimeters (mm) unless otherwise specified.

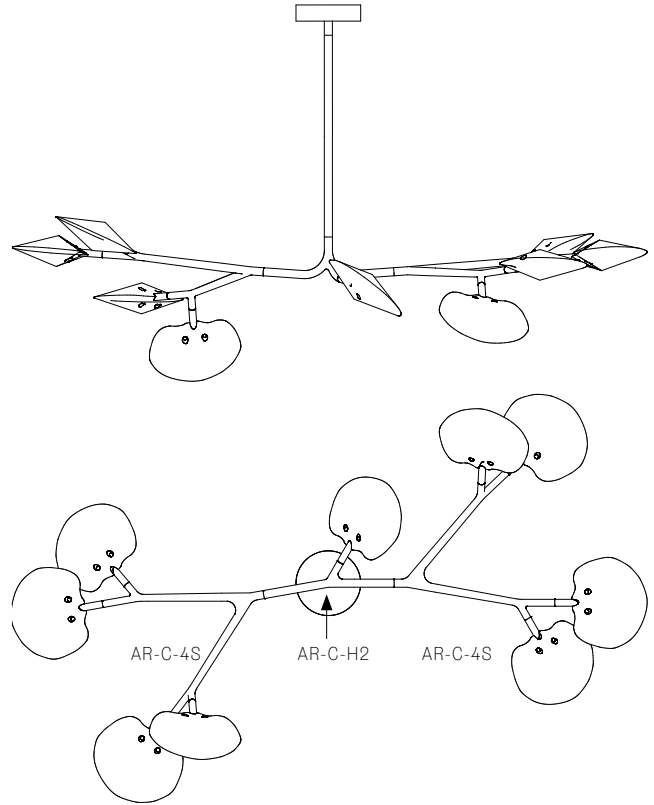
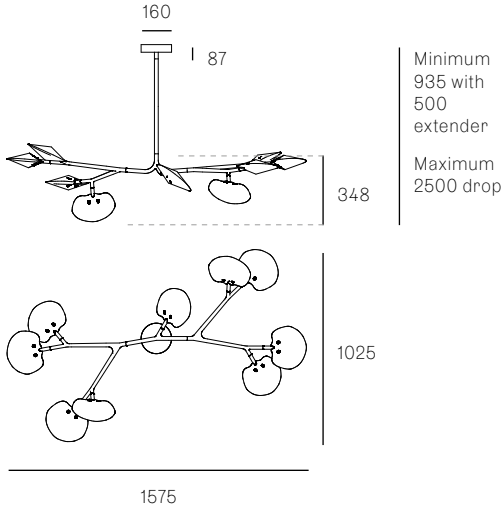

16.11A.1

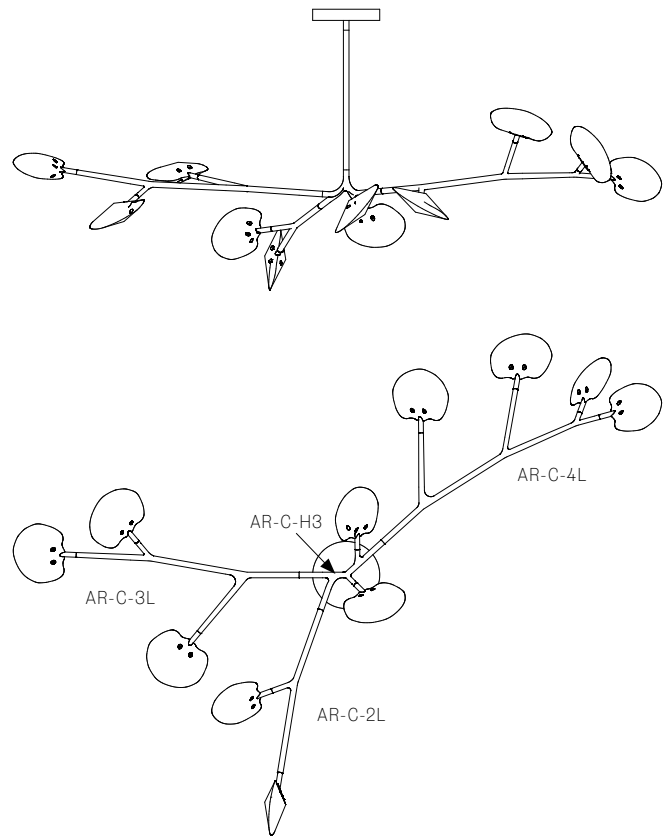
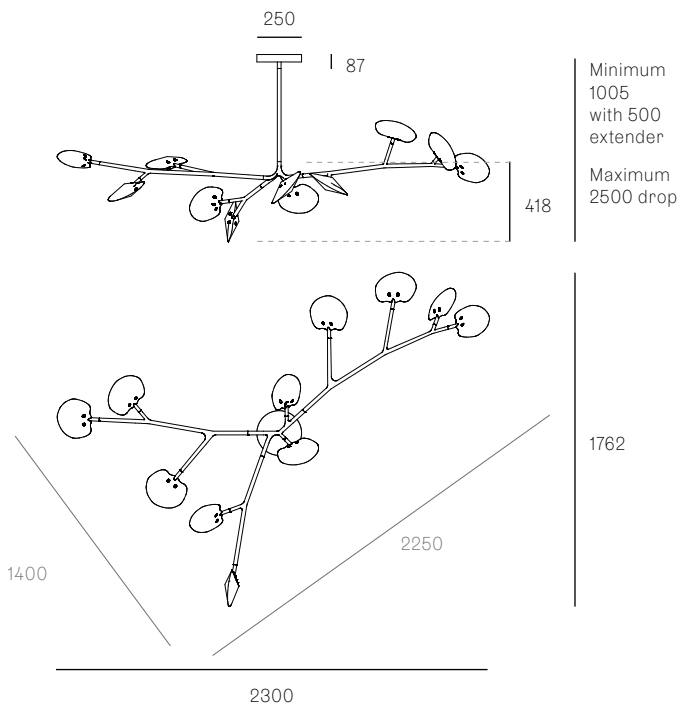

16.11A.2

All dimensions are in millimeters (mm) unless otherwise specified.

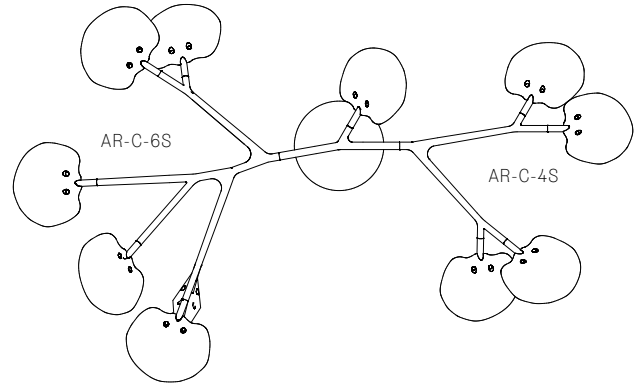
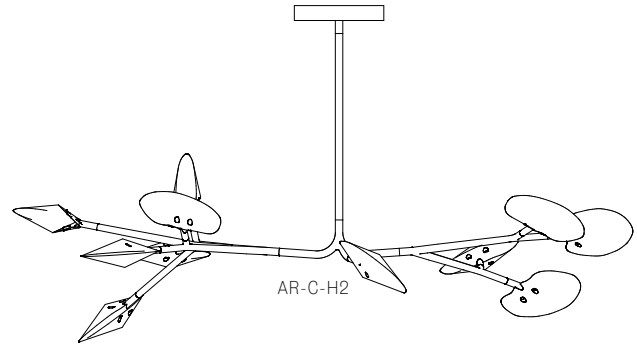
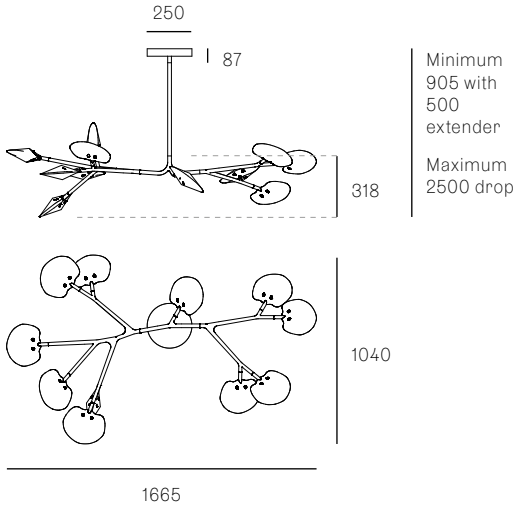

16.13A.1

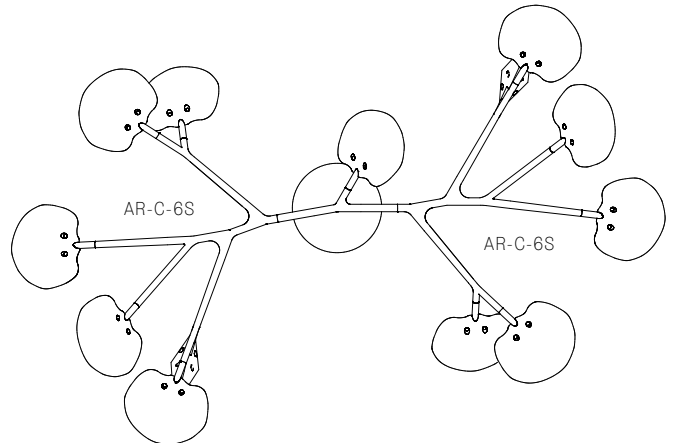
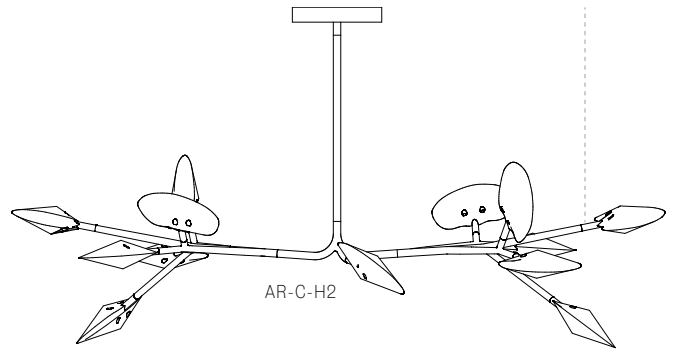
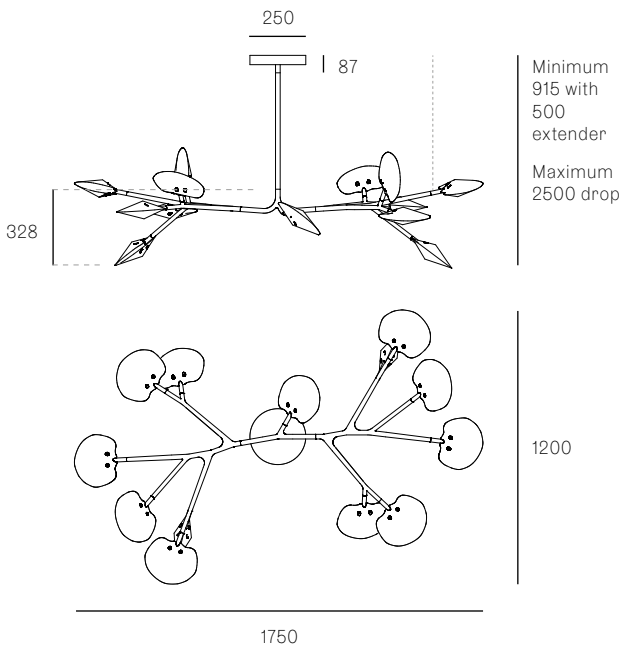

16.17A.1

All dimensions are in millimeters (mm) unless otherwise specified.

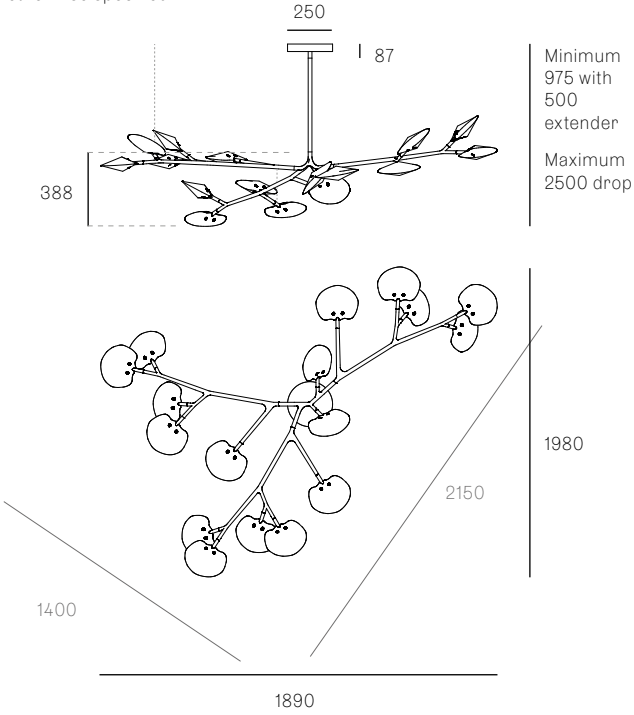

Minimum
975 with
500
extender
Maximum
2500 drop

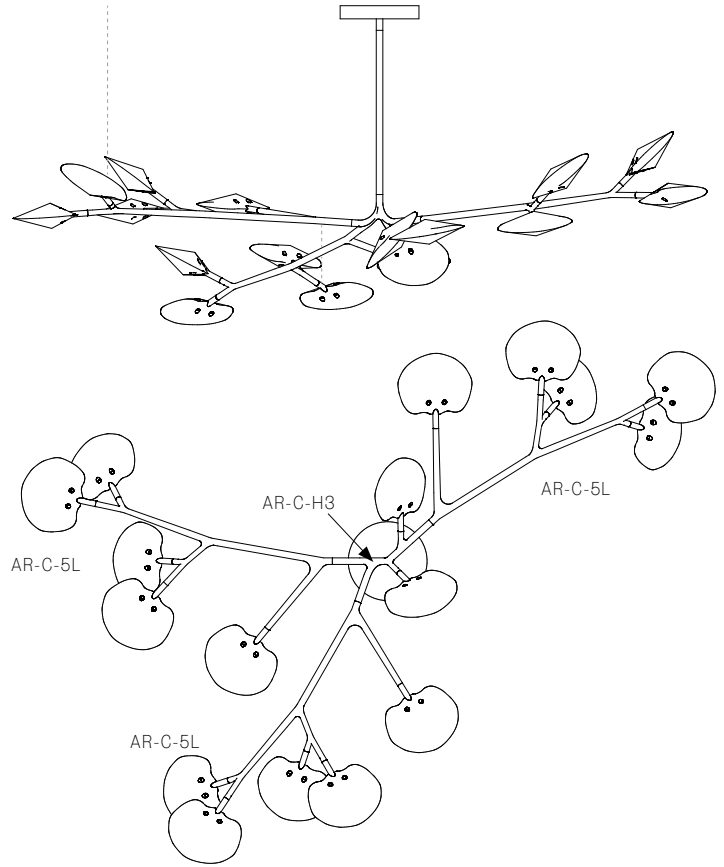

16.20A.1

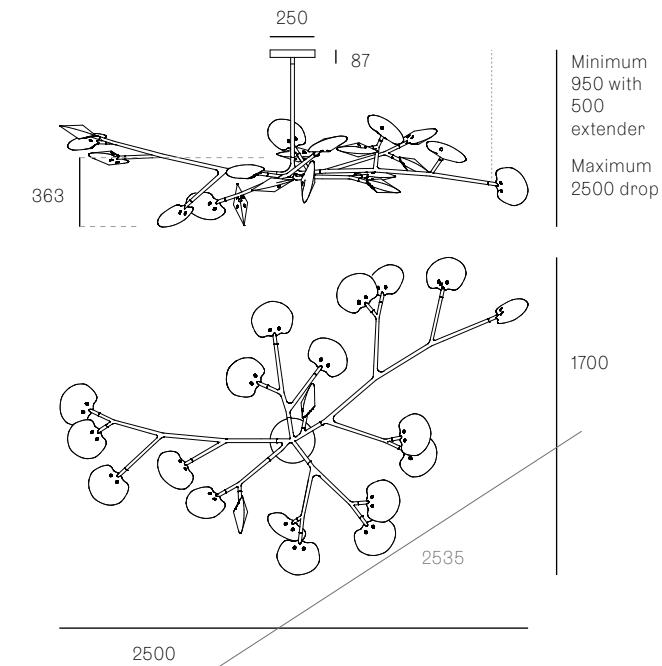

Minimum
950 with
500
extender
Maximum
2500 drop

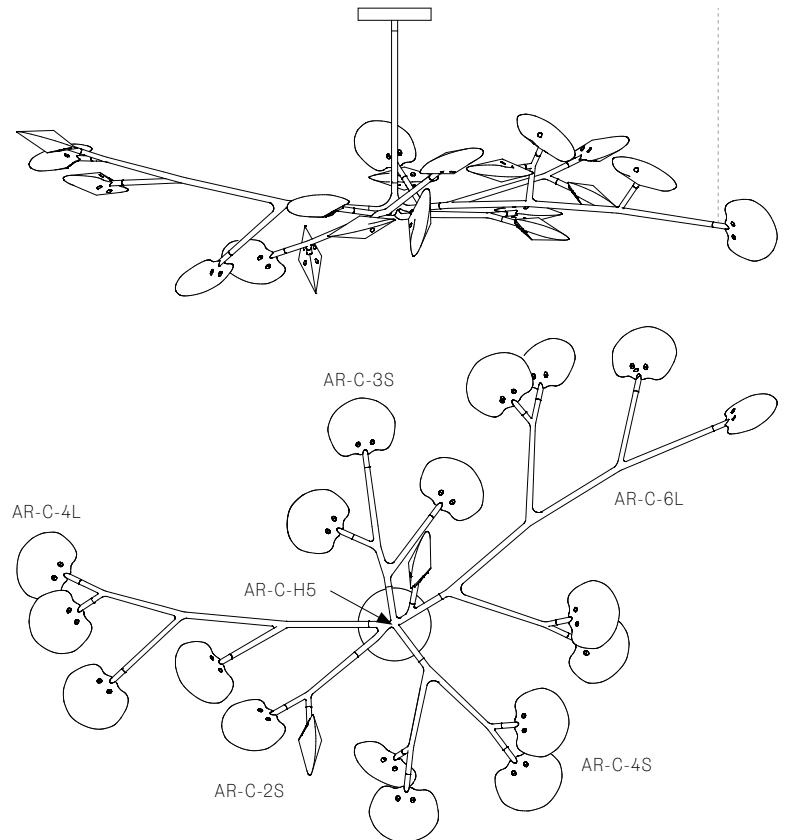

16.23A.1

All dimensions are in millimeters (mm) unless otherwise specified.

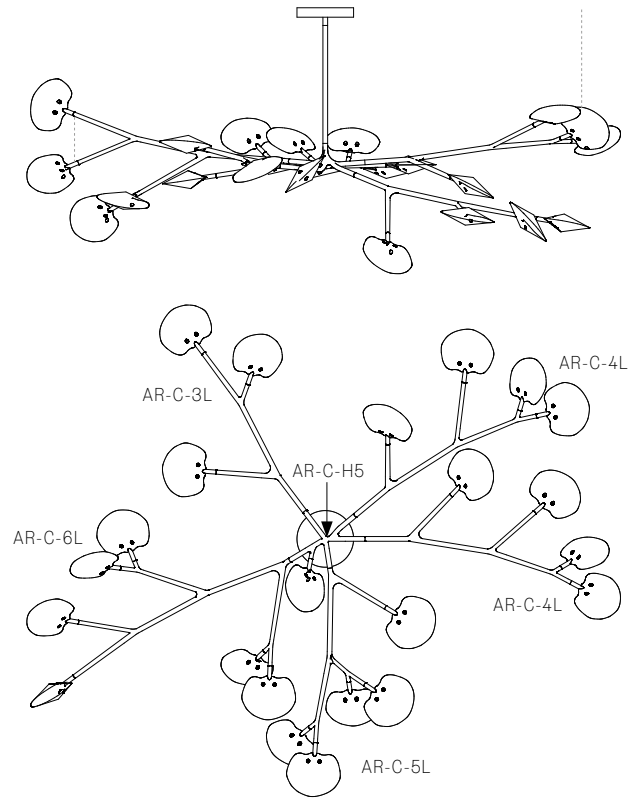
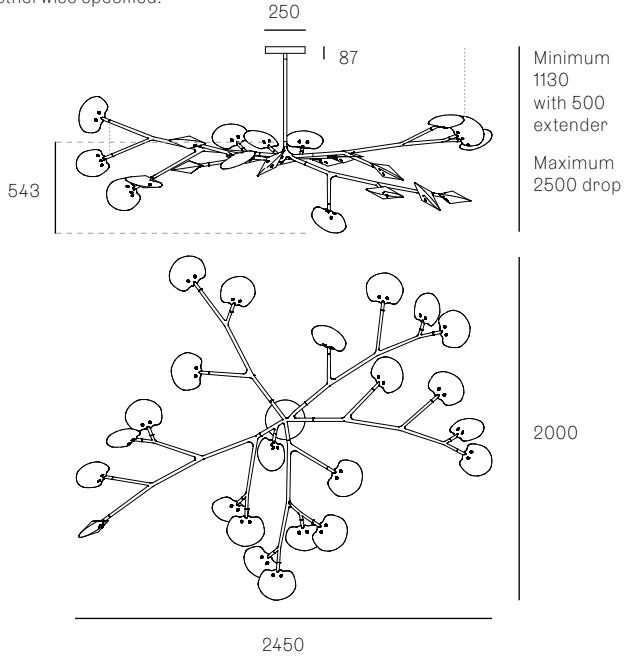

16.33A.1

